

DESCRIPTION

- ELECTRONIC BALLAST
- ELECTRONIC TRANSFORMER
- SWITCH MODE POWER SUPPLY

FEATURES:

- LOW THERMAL RESISTANCE
- HIGH INPUT RESISTANCE
- FAST SWITCHING
- ROHS COMPLIANT

MAXIMUM RATINGS (T_c=25°C)

PARAMETER	SYMBOL	VALUE	UNIT
Drain-source Voltage	VDS	600	V
gate-source Voltage	VGS	±25	V
Continuous Drain Current (T _C =25°C)	ID	11	A
Drain Current-Pulsed	IDM	44	A
Total Dissipation	PD	90	W
Junction Temperature	T _j	150	°C
Storage Temperature	T _{stg}	-55-150	°C
Single Pulse Avalanche Energy (I _{AS} =11A)	EAS	200	mJ

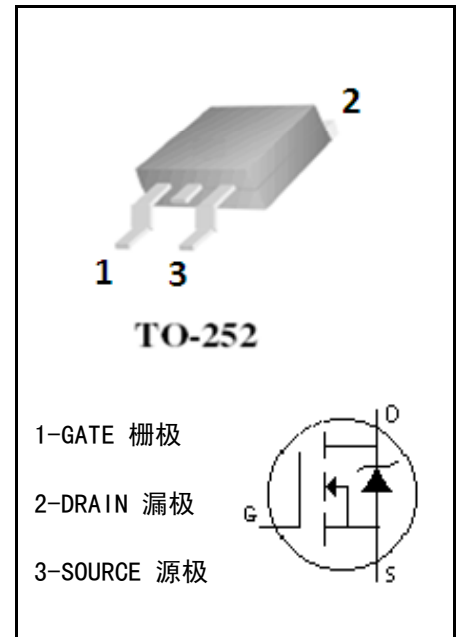
MECHANICAL

ELECTRONIC CHARACTERISTICS (T_c=25°C)

CHARACTERISTICS	SYMBOL	TEST CONDITION	MIN	MAX	UNIT
Drain-source Breakdown Voltage	BVDSS	VGS=0V, ID=250uA	600		V
Gate Threshold Voltage	VGS (TH)	VGS=VDS, ID=250 μ A	2	4	V
Drain-source Leakage Current	IDSS	VDS=600V, VGS=0V		1	uA
Drain-Source Diode Forward Voltage	VSD	VGS=0V, IS=11A		1.5	V
Gate-body Leakage Current (VDS = 0)	IGSS	VGS=±25V		±0.1	uA
Forward Transconductance	gfs	Vds=10V Id=5.5A	4		S
Static Drain-source On Resistance	RDS (ON)	VGS=10V, ID=5.5A		0.38	Ω
Thermal Resistance Junction-case	RthJ-c			1.39	°C/W

■ DYNAMIC CHARACTERISTICS (T_c=25°C)

CHARACTERISTICS	SYMBOL	TEST CONDITION	MIN	TYP	MAX	UNIT
Input Capacitance	C _{iss}	V _{DS} =50V, V _{GS} =0V, f=1.0MHz	-	790	-	pF
output Capacitance	C _{oss}		-	60	-	pF
Reverse Transfer Capacitance	C _{rss}		-	3.6	-	pF

■ SWITCHING CHARACTERISTICS (T_c=25°C)

CHARACTERISTICS	SYMBOL	TEST CONDITION	MIN	TYP	MAX	UNIT
Turn-On Delay Time	t _{d(on)}	V _{DD} =300V, I _D =5.5A, R _G =25Ω, V _{GS} =10V	-	3	-	ns
Turn-On Rise Time	t _r		-	8	-	ns
Turn-Off Delay Time	t _{d(off)}		-	30	-	ns
Turn-Off Rise Time	t _f		-	10	-	ns
Total Gate Charge	Q _g	V _{DS} =480V, I _D =11A, V _{GS} =10V	-	27	-	nC
Gate-Source Charge	Q _{gs}		-	4	-	nC
Gate-Drain Charge	Q _{gd}		-	14	-	nC

■ DRAIN-SOURCE DIODE MAXIMUM RATINGS AND CHARACTERISTICS (T_c=25°C)

CHARACTERISTICS	SYMBOL	TEST CONDITION	MIN	TYP	MAX	UNIT
Max. Diode Forward Current	I _s		-	-	11	A
Max. Pulsed Forward Current	I _{SM}		-	-	44	A
Diode Forward Voltage	V _{SD}	V _{GS} =0V, I _S =11A	-	-	1.5	V
Reverse Recovery Time	t _{rr}	V _{GS} =0V, I _S =11A, dI _F /dt=100A/μs, V _{DD} =100V	-	230	-	ns
Reverse Recovery Charge	Q _{rr}		-	2	-	μC



CHARACTERISTICS CURVE

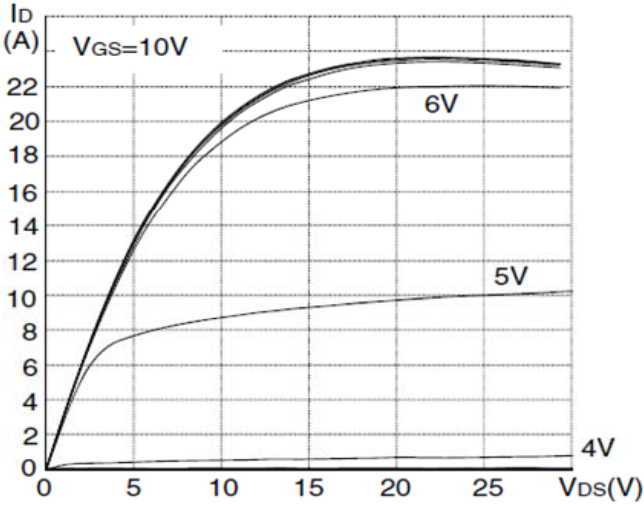

Output Characteristic

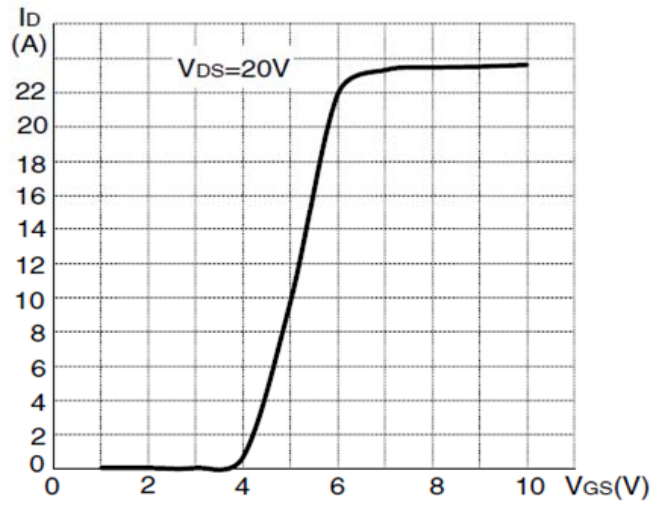

Transfer Characteristic

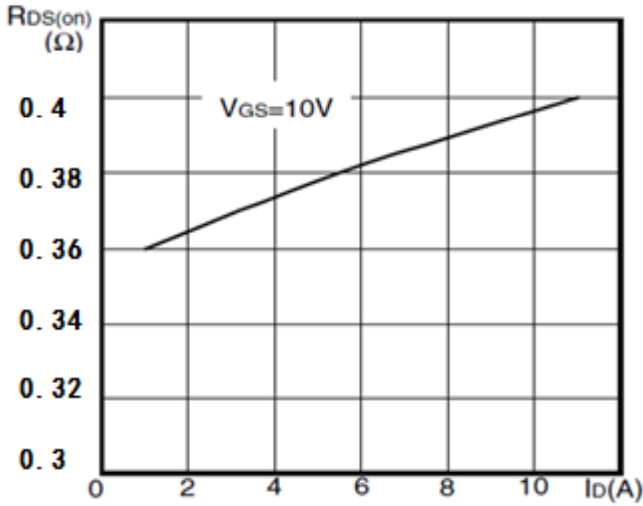

On Resistance Vs Drain Current

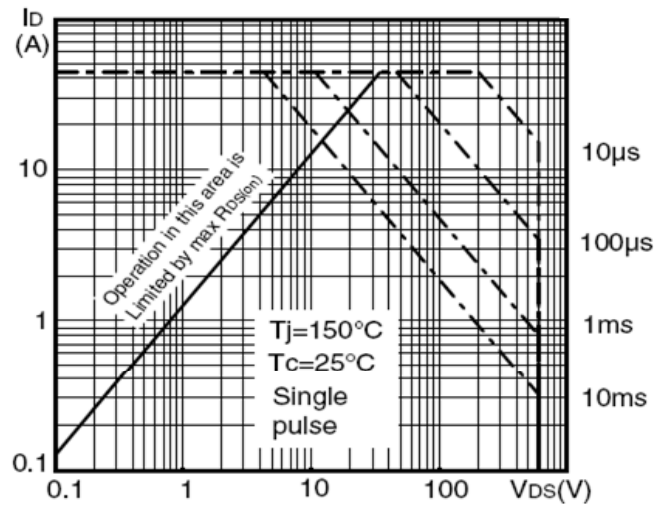

Safe Operating Area

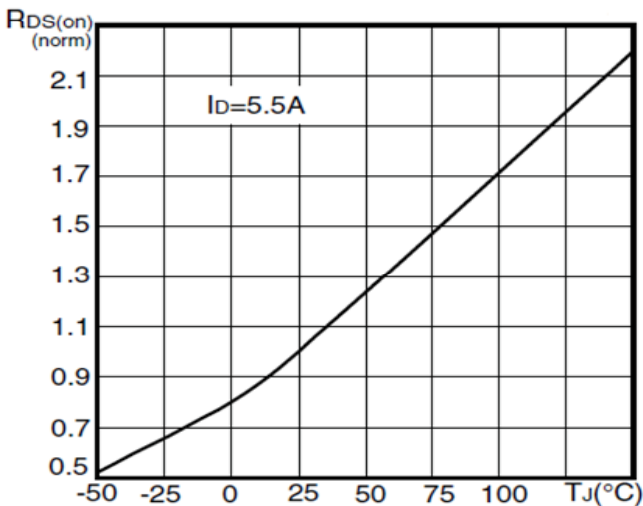

On Resistance Vs Junction Temperature

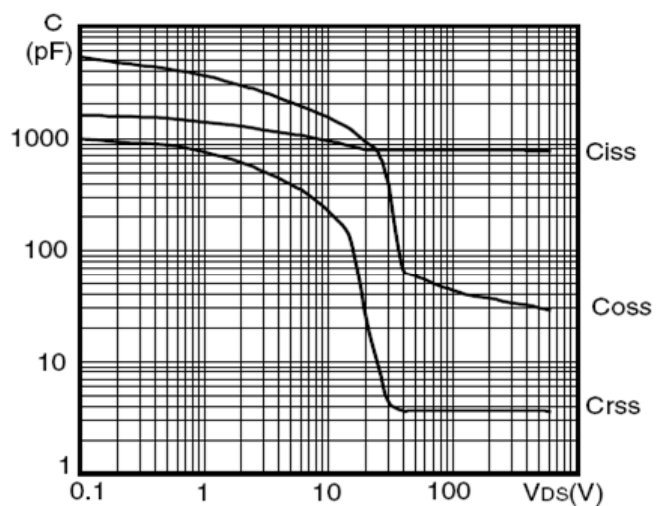

Capacitance



CHARACTERISTICS CURVE

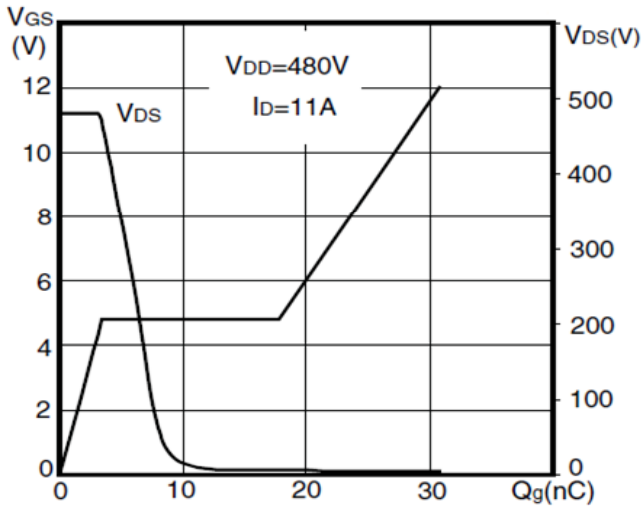

Gate Charge Waveform

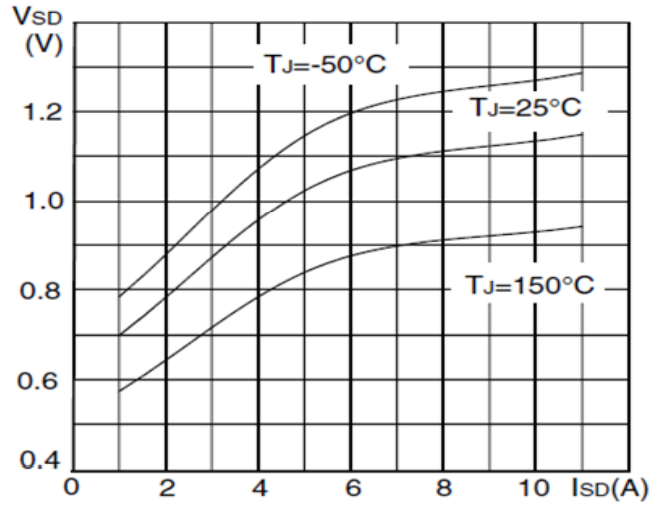

Source-Drain Diode Forward Voltage

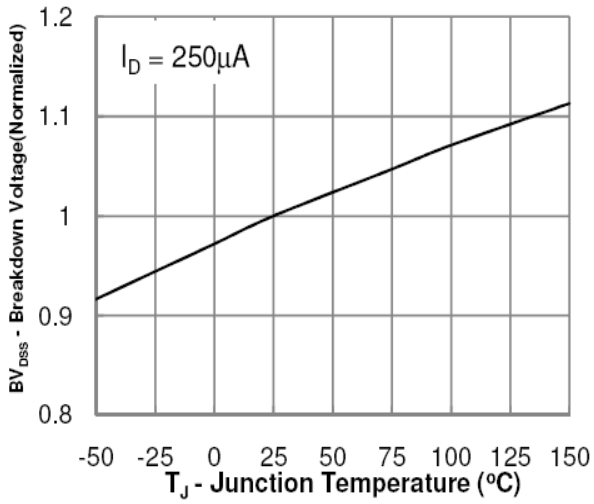

Breakdown Voltage Vs Junction Temperature

TO-252 MECHANICAL DATA

UNIT: mm

SYMBOL	MIN	NOM	MAX	SYMBOL	MIN	NOM	MAX
A	2.10		2.50	E	5.80		6.30
B	0.80		1.25	e1	2.25	2.30	2.35
b	0.50		0.85	e2	4.45		4.75
b1	0.50		0.90	L1	9.50		10.20
b2	0.45		0.60	L2	0.90		1.45
C	0.45		0.60	L3	0.60		1.10
D	6.35		6.75	K	-0.1		0.10
D1	5.10		5.50				

